

The background features a gradient from red at the top to blue at the bottom, overlaid with faint technical diagrams including circular gauges with numerical scales (40, 150, 160, 170, 180, 200, 210, 220, 230, 240, 250, 260) and various circular and dashed lines. A starry space pattern is visible in the lower right.

NASA GRC MBSE IMPLEMENTATION STATUS

EDITH PARROTT/GRC

KATIE TRASE

RANDI GREEN

DENISE VARGA

JOE POWELL

FEBRUARY 17, 2016

AGENDA

- GRC MBSE Adoption Timeline
- Forums Advancing GRC MBSE Adoption
- GRC MBSE Project History
- GRC MBSE Adoption Challenges
- Future Initiatives

TIMELINE

2007

- Concept brought to GRC

2009

- NASA SEWG Started MBSE Study

2010

- PTC Training on SysML
- GRC Working Group (WG) kick-off

2011

- NoMagic Architecture Framework Training
- GRC WG perform MSBE Tool Trade

2012

- InterCAX 101/201 Training
- GRC Practitioner's Forum kick-off

2013

- Internal MBSE Overview Training
- GRC WG developed MBSE Roadmap

2014

- Internal Hands-On Training

2015

- Internal MBSE 1-day Hands-on Training
- InterCAX 101/201 Training
- InterCAX 891 Training

2016

- GRC WG developed MBSE Quick Kickstart document

MBSE WORKING GROUP PURPOSE

Improve practice of systems engineering at GRC by:

- Increasing Center's understanding and utilization of MBSE
- Improving MBSE capabilities within Systems Engineering Division
- Maintaining awareness of MBSE's application across the center and agency

MBSE PRACTITIONER'S FORUM PURPOSE

Collaborative setting for Modelers to:

- Exchange ideas
- Discuss challenges
- Keep skills fresh with training sessions

SAMPLING OF PROJECTS CURRENTLY APPLYING MBSE AT GRC

GRC Mission/Project	MBSE Partner Center	Architecture	ConOps	Requirements	Interfaces	Structural and Behavioral	Tool Integration	Trade Studies	V & V
Integrated Power, Avionics, and Software Lab	JSC	X		X	X	X			
Space Communication and Navigation	JPL, GSFC	X	X		X		X	X	
Asteroid Robotic Redirect Mission	JPL	X	X	X	X	X	X		X
Space Launch System	MSFC	X		X		X			
NESC ESD V&V Plan Assessment	JPL, KSC			X					X
Advanced Modular Power Systems	JSC					X			
Gondola for High Altitude Planetary Science	GSFC, MSFC	X	X	X	X		X		X

SAFFIRE-I, -II, AND -III PROJECT

- Project Overview:
 - Class D experiment for Spacecraft Fire Safety Demonstration Project, SAFFIRE-1 launching in March 2016
 - Each Saffire flight unit has same configuration, with different samples
- Model used to:
 - Provide training opportunity at GRC
 - Convert Saffire design and configuration data to a system model
 - Represent
 - Physical architecture, Interfaces
 - Use cases, experiment operation
 - Requirements
- Utilized and extended custom requirements stereotypes to capture project-specific verification methods

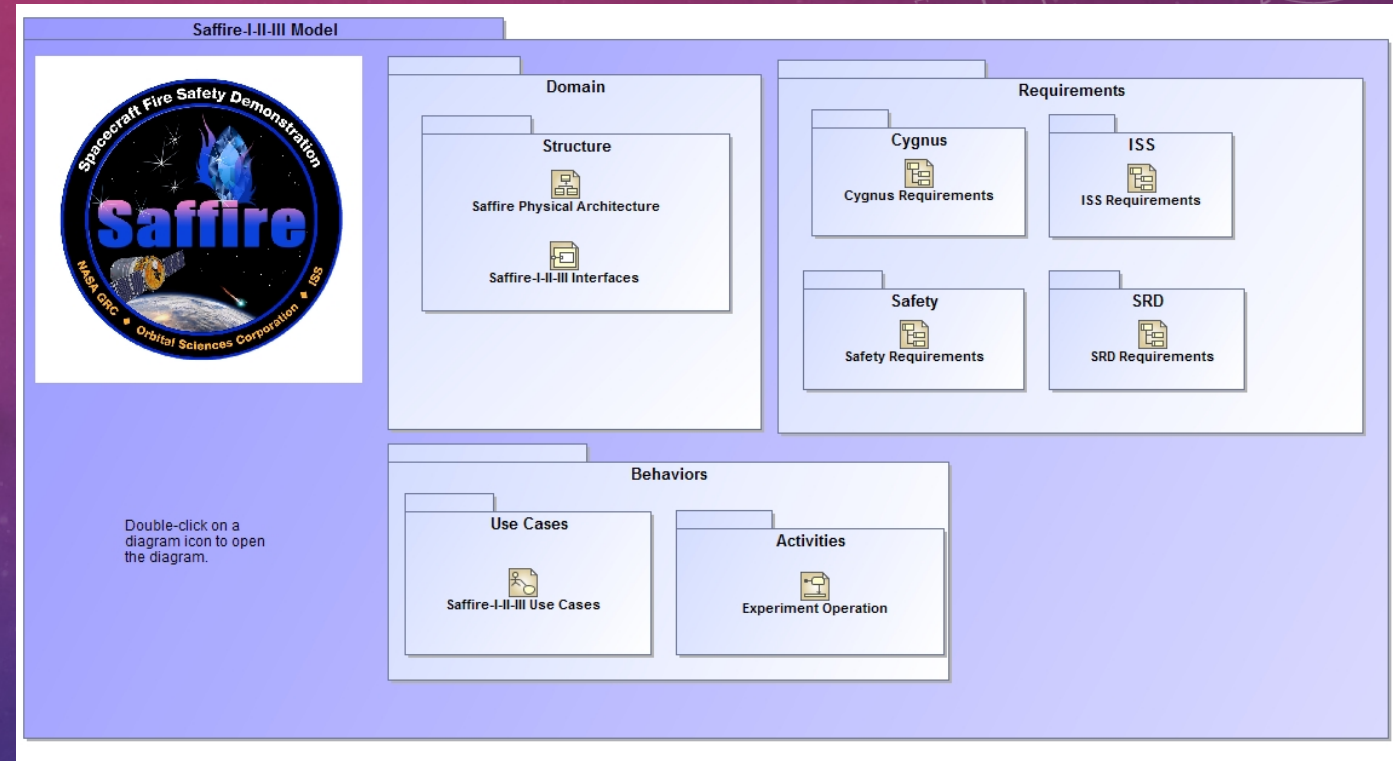

GONDOLA FOR HIGH ALTITUDE PLANETARY SCIENCE

- Modeling Objectives:
 - Model requirements and allocate to subsystems and components
 - Tie requirements to verifications
 - Generate Use Cases to define mission scenarios
 - Manage interfaces
 - Maintain and manage Master Equipment List and Power Equipment List
 - Integrate with simulations for pointing control system and science target availability at various launch sites over varying launch dates and mission durations
- Top Technical Challenges:
 - Design to allowable mass for a SuperPressure balloon on a 100-day mission
 - Achieve <1 arcsecond pointing accuracy and stability
 - Design to be refurbishable within a year for next flight at a cost of $<20\%$ of original development
 - Protect equipment while waiting for recovery in harsh environments such as Antarctica
- Organizational Challenge:
 - Develop platform elements at 4 different NASA locations – MSFC, GSFC, GRC, WFF

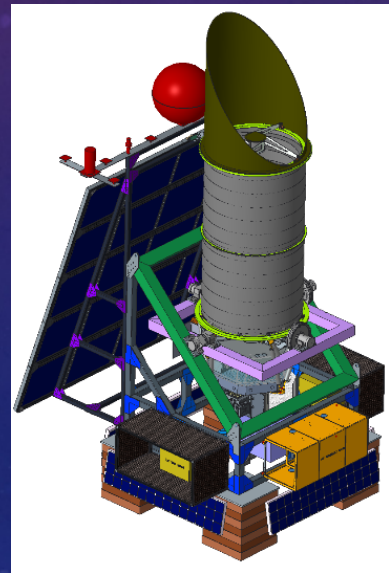

NESC EXPLORATION SYSTEMS DEVELOPMENT (ESD) V&V PLAN ASSESSMENT

- MBSE training opportunity offered by NESC, led by JPL
- Purpose: Assess ESD cross-program V&V planning and implementation
- Model used to:
 - Integrate V&V data from various sources
 - Establish formal relationships between integrated data
 - Illuminate gaps or coverage between plans
- GRC Focus:
 - Modeling associated with “Integrated Abort” topic
 - Architecting model results reporting process

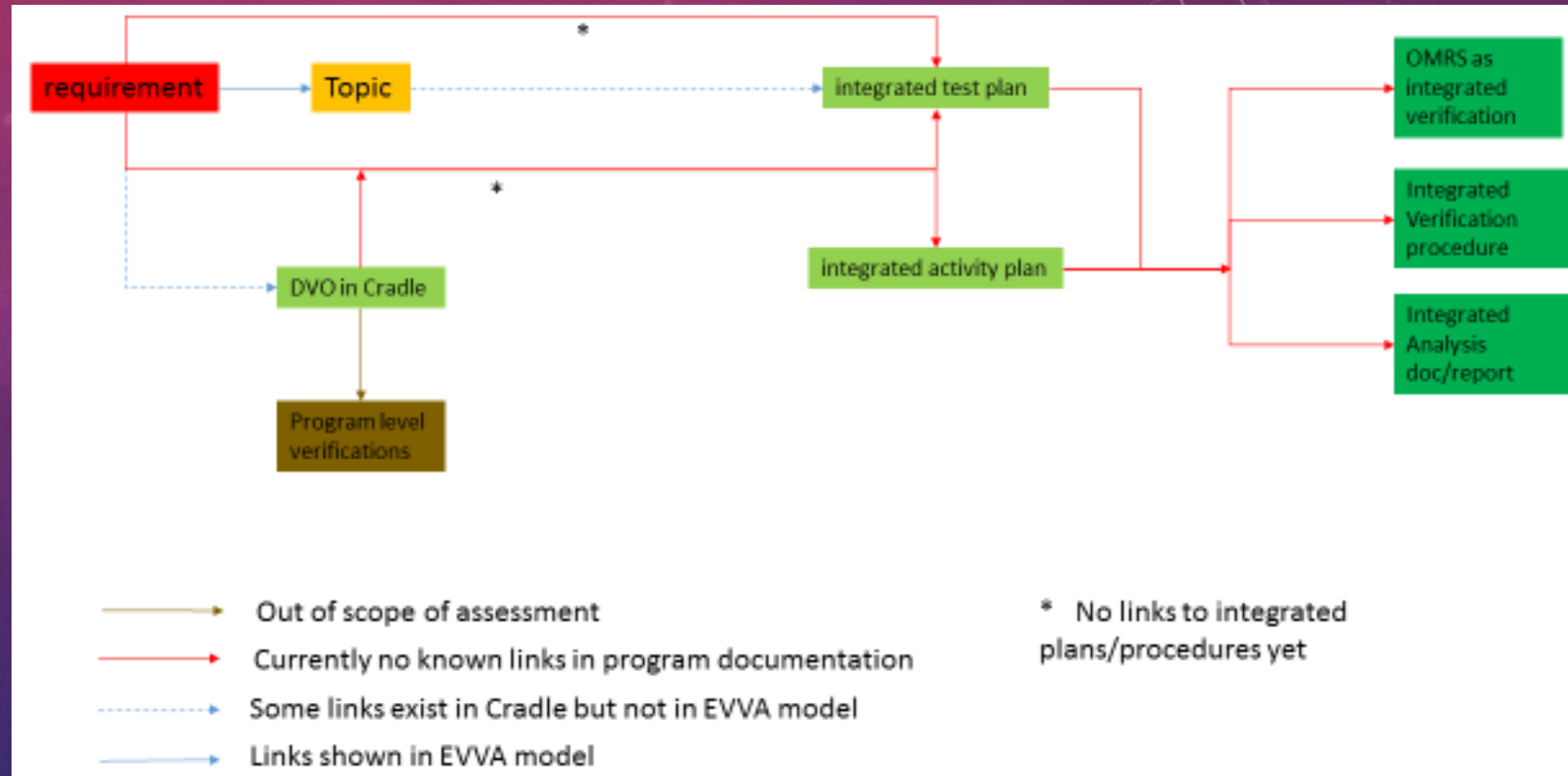

ASTEROID ROBOTIC REDIRECT MISSION

GRC Participation:

- Concept of Operations Modeling
 - Spacecraft function definition
 - Lead for two mission phase concept models
- Requirements Modeling
 - Relating requirements to
 - Satisfying functions (from ConOps) and project elements
 - Allocated project elements
 - Link Government-Furnished Equipment requirements with spacecraft requirements
- Product Breakdown Structure to subsystem level

Other ARMM Modeling: Project System ConOps, WBS, project personnel, interfaces...

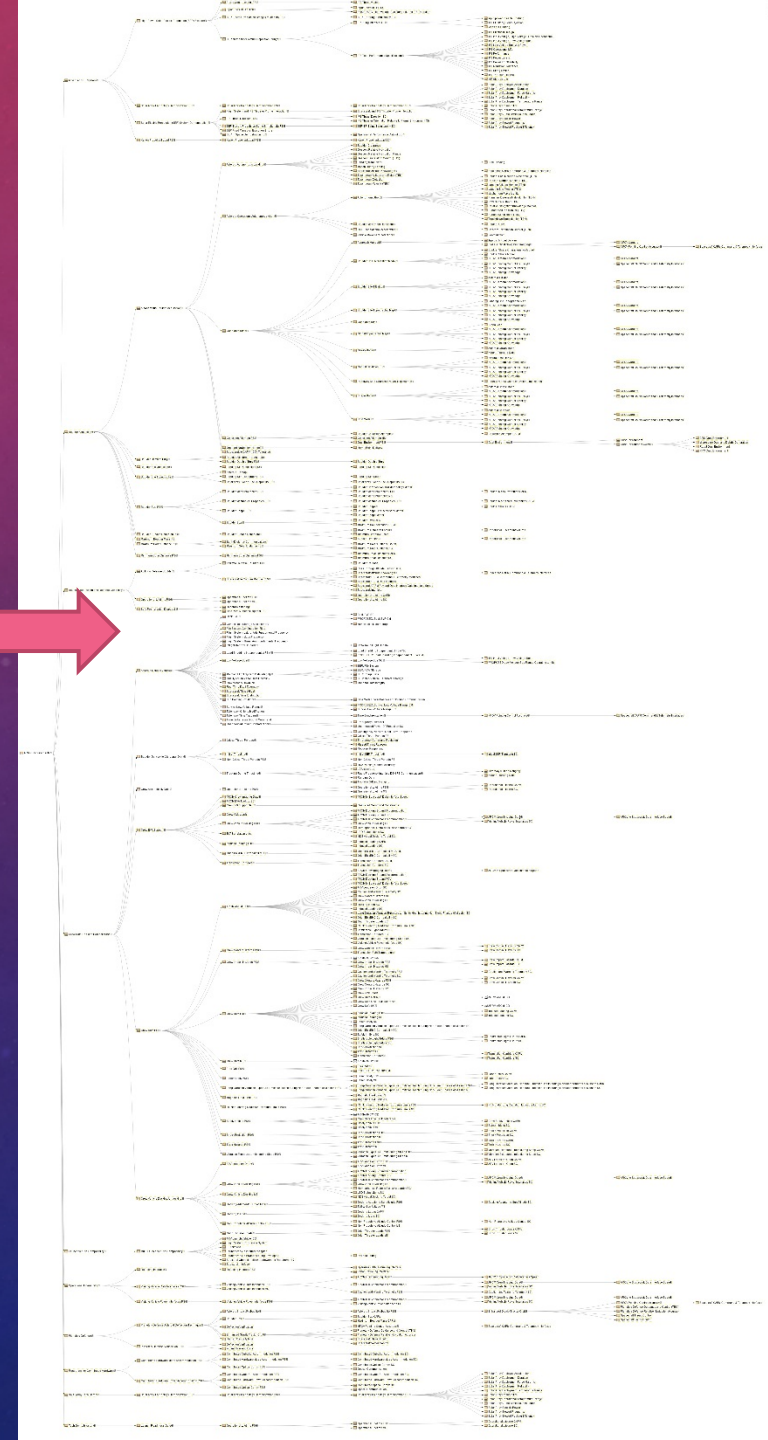

ASTEROID ROBOTIC REDIRECT MISSION

[1.2 Critical Deployments Top-Level Activities]

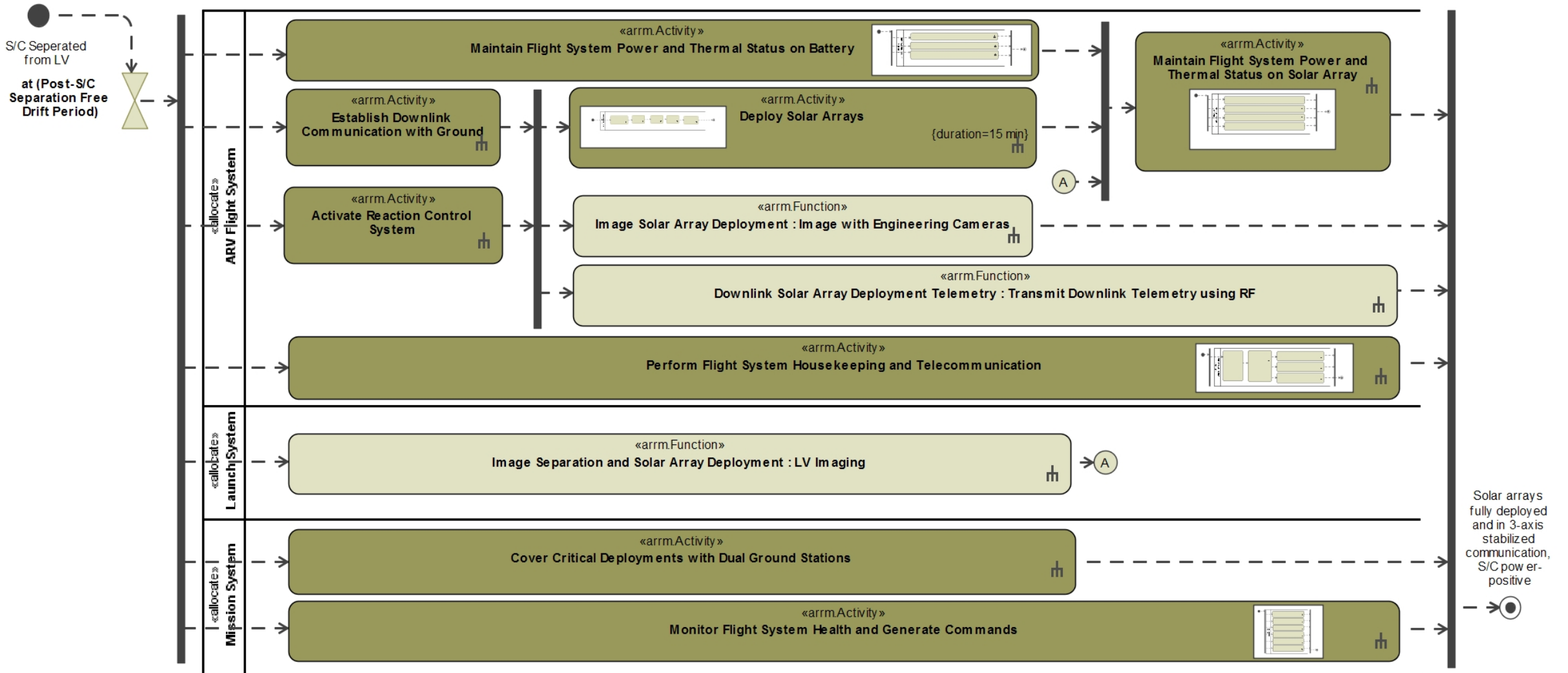



ASTEROID ROBOTIC REDIRECT MISSION

Benefits

- Requirements validation through ConOps
- Shared model facilitates communication across team
- Enhanced ability to track deliverable progress
- Mentorship by more experienced modelers

Challenges

- Cross-center access of model (VPN)
- Huge size of model (>150 MB)
- Larger modeling team
-  Modeling tool instability
-  Slow tool interface
- Occasional loss of work
- Long download/commit times (>20 min)

GRC MBSE ADOPTION CHALLENGES

- Significant investment required to become effective MBSE practitioner
 - Projects budgets are tight and are unable to devote money (in development time or resources) for SE to learn
 - Learning how to read SysML effectively
 - Jumping from basic tool knowledge to modeling to satisfy SE deliverables
 - Applying best practices often requires failing a few times, first
- Collaboration in a multi-center modeling effort
 - Model storage so all SE team members can access efficiently
 - Model access so all domain team members can access effectively
- Resources
 - More experienced modelers often do not have availability to mentor less experienced or capture lessons learned
 - Contracted modeling support can be expensive

FUTURE MBSE ASPIRATIONS AT GRC

- Facilitate stakeholder access to model
 - Setting up an OpenMBEE instance (web interface to model viewpoints)
- Expand outside of the architectural models
 - Integrate SysML with other tools, for simulation
- Expand support to Practitioners
 - Continue to expand the GRC plug-in tool capabilities
 - Capture best practices and share knowledge: more “kickstarters”
- Increase percentage of new projects using MBSE as a baseline