



# Deadly Efficiency:

## American Airlines Flight 191

### Leadership ViTS Meeting

July 2010

**Bryan O'Connor**

*Chief, Safety and Mission Assurance*

**Wilson B. Harkins**

*Deputy Chief, Safety and Mission Assurance*



This and previous presentations are archived at:  
<https://sma.nasa.gov/>

# THE MISHAP

*On May 25, 1979, American Airlines Flight 191 suffered catastrophic damage when the left engine tore away from the aircraft during takeoff and careened onto the tarmac below, bringing part of the wing and dozens of hydraulic and electrical lines with it. Seconds later, the McDonnell-Douglas DC-10 crashed near a trailer park less than a mile from the runway. Along with 2 people on the ground, all 271 passengers and crew lost their lives in one of the deadliest mishaps in American commercial aviation history.*

## McDonnell-Douglas DC-10

- Powered by three GE engines: one on each wing and one on the tail
- Wing-mounted engines were mounted onto pylons.
- Pylons were attached to wings via forward and aft bearings.

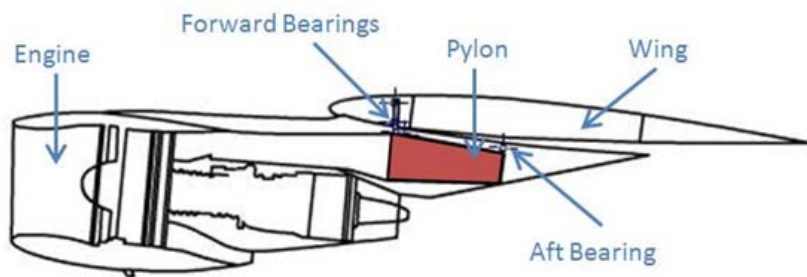

## Spherical Bearing Replacement

- McDonnell-Douglas issued two bulletins calling for replacement of the spherical bearings on the forward and aft bulkheads of the pylon.

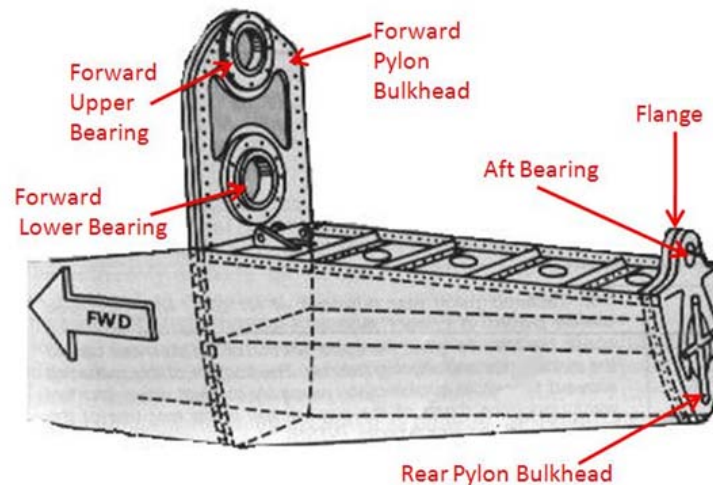

# WHAT HAPPENED?

## Engineering Change Order

- McDonnell-Douglas specified the engine should be disconnected from the pylon before the pylon was removed from the wing.

- American Airlines devised an Engineering Change Order (ECO) that reduced the number of wire-disconnects and the number of man-hours needed for the job.

- The ECO called for disconnecting the engine and pylon as a single unit and then lowering the unit with a forklift.

- American Airlines instituted the ECO even though McDonnell-Douglas reviewed the procedure and advised against it.

- Two months prior to the mishap flight, maintenance personnel did not follow the steps outlined in the ECO: instead of removing the pylon's forward bearings first, they removed the aft bearings prior to the forward bearings.

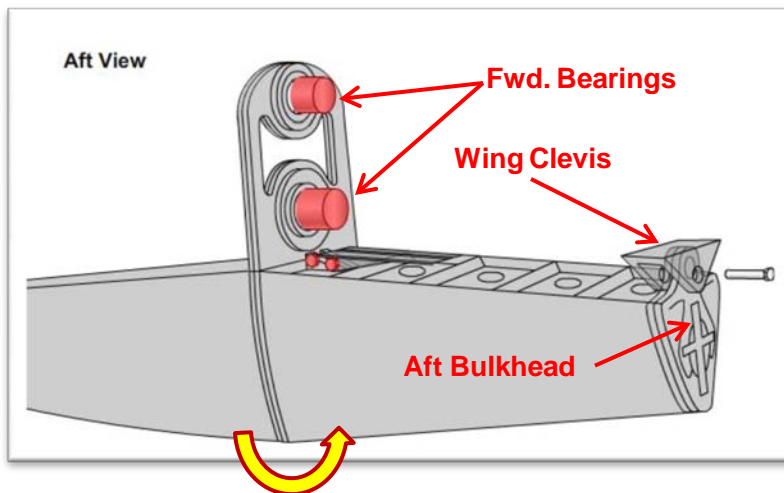
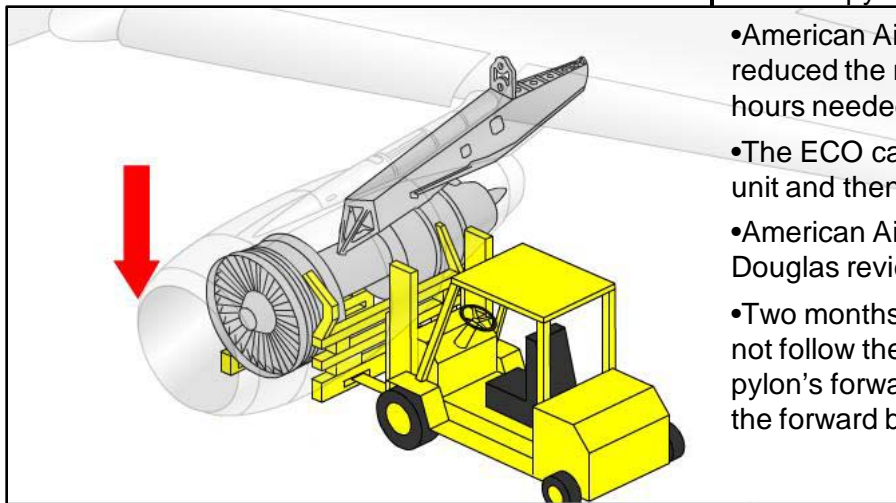

**During this procedure, manipulations of the forklift allowed the assembly to rotate, and the pylon's rear flange contacted the wing clevis. The force from this contact resulted in an undetected crack on the aft bulkhead that propagated on subsequent flights.**

# WHAT HAPPENED?

## Engine Separation

- May 25, 1979: American Airlines Flight 191 began its takeoff run.
- Just as the plane became airborne, the left engine tumbled over the wing and fell to the runway.
- Hydraulic fluid poured out of the severed lines, and electrical power to cockpit warning systems was cut off.
- The pilots could not see what happened and assumed an engine failure had occurred. They decreased airspeed from 165 to 153 knots according to standard procedure for engine failure during takeoff.



## Asymmetric Stall and Loss of Control

- Because hydraulic system #1 was the only mechanism that locked the left wing slats in an extended position, loss of hydraulic fluid caused the leading-edge slats on the left wing to retract.
- With leading-edge slats retracted, the left wing could not generate lift at the reduced speed, and the aircraft entered an uncontrollable roll to the left.
- Seconds later, the aircraft plummeted into an open field, killing all 271 people on board and 2 more people on the ground.



# PROXIMATE CAUSE



A 10-inch, horizontal fracture on the flange of the rear bulkhead weakened the pylon's structure to the point that it could not sustain the loads imposed upon it. During takeoff, the entire engine-eylon assembly tore away, severing hydraulic and electrical lines in the process. Loss of hydraulic fluid caused the leading-edge slats to retract; loss of electrical power to the stall warning system cost critical seconds of situational awareness, leaving the crew unable to save the aircraft.



# UNDERLYING ISSUES



## UNFORESEEN ECO DAMAGE POTENTIAL

- 
- Engineers did not conduct a formal fault analysis regarding the effect the forklift would have on the engine-eylon assembly in the event of a forklift malfunction or a human error.
  - Forklift placement anywhere other than directly beneath the center of gravity would result in a torque that could overstress the joints, resulting in a crack on the bulkhead.
  - Given the precision required for the procedure, forklift operators did not receive sufficient training for the task.
  - Maintenance personnel were not required to follow the exact order of processes in the ECO, nor were they required to report deviations from those procedures.



## DESIGN FLAWS

- 
- The hydraulic system was the sole locking mechanism for the leading-edge slats (other designs included mechanical locks).
  - DC-10 exhibited a lack of redundancy in the stick-shaker motor and stall warning system.
  - The pylons themselves were susceptible to maintenance damage because of tiny clearances at attach points.



## PREVIOUS INCIDENT NOT REPORTED BY DIFFERENT OPERATOR

- 
- Continental Airlines also used the forklift method to change bearings on its DC-10's and discovered near-identical damage on the bulkheads of two of its pylons months before the crash.
  - Continental classified the damage as minor and did not report it to the FAA.

# FOR FUTURE NASA MISSIONS

- Innovative thought to streamline processes can reduce costs, but we must ensure an apparently more efficient process does not introduce needless safety risks.
- We must be vigilant in our design of safety critical components, building robustness or redundancy into the design to forestall single-point failures.
- Cross-communication of critical damage or failure incidents is vital to timely implementation of risk controls by all operators of like systems.



**A firefighter wades through the rubble that was American Airlines Flight 191.**

Photo by Dave Tonge, *Daily Herald*